

FIXED UNIDIRECTIONAL FLOW CONTROL VALVE

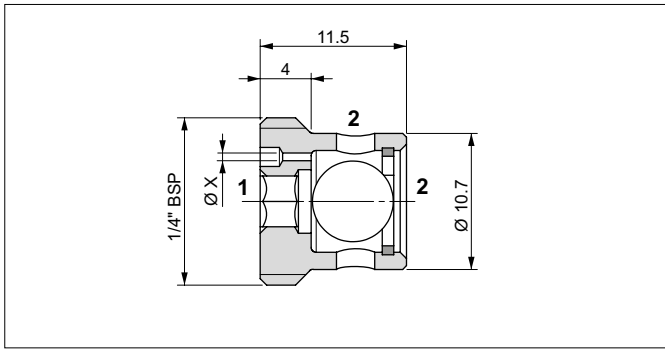

The valves control the flow in a single direction (2 to 1, the flow in opposite direction in free).
The flow is reduced by the control hole X which determines the flow rate (not compensated). Valves made steel.

HYDRAULIC FEATURES

Max. working pressure	210 bar
Max. Flow	20 l/min
Hydraulic fluid	DIN 51524 Mineral oils
Fluid viscosity	10 ÷ 500 mm ² /s
Fluid temperature	-25°C ÷ 75°C
Ambient temperature	-25°C ÷ 60°C
Max. contamin. level class with filter	ISO 4406:1999 - class 19/17/14
Weight	0.022 kg
Tightening torque	16 ÷ 18 Nm

HYDRAULIC SYMBOL

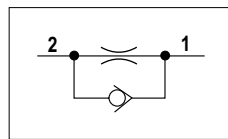

PRESSURE DROPS

Free flow 1 → 2

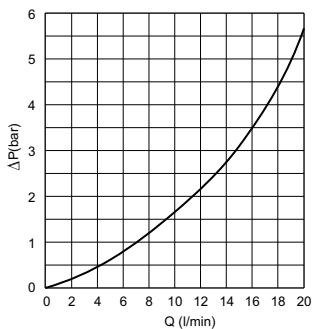

Controlled flow 2 → 1
(VSU 04 06...)

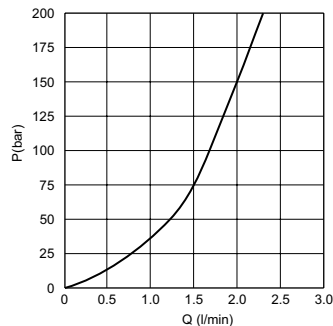

Controlled flow 2 → 1
(VSU 04 16...)

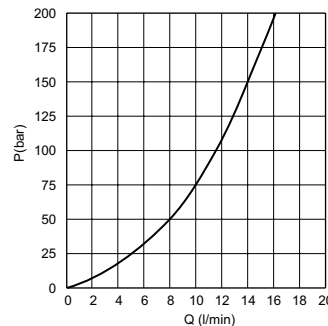

Fluid used: mineral based oil with viscosity 46 mm²/s at 40°C.

SEAL

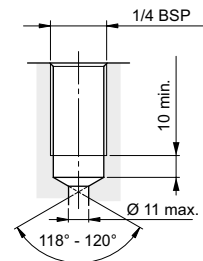

SERVICE EXAMPLE

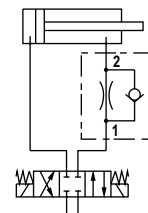

ORDERING CODE

