

CONNECTORS FOR CONTROL VALVES IN ACCORDANCE WITH DIN 43650 / ISO 4400

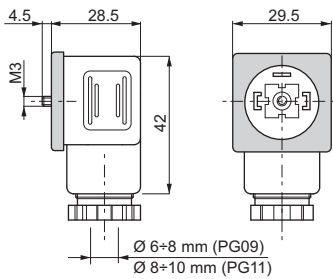

Connector	Protection level	Type	Cable gland	Code
Standard	IP65	Black color	PG09	V86 05 0002
		Grey color	PG09	V86 05 0004
		Black color	PG11	V86 05 0006
		Grey color	PG11	V86 05 0008
Lens cover with pilot light (1)	IP65	12 VAC/VDC	PG09	V86 10 0018
		24 VAC/VDC	PG09	V86 10 0012
		115 VAC/VDC	PG09	V86 10 0020
		230 VAC/VDC	PG09	V86 10 0022

(1) do not use for proportional versions

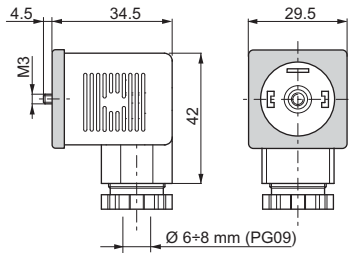

Connector	Protection level	Type	Cable gland	Code
With rectifier (1) Inlet voltage 12÷230 VAC Outlet voltage 9÷205 VDC	IP65	Black color	PG09	V86 20 0002
		Grey color	PG09	V86 20 0004
Lens cover with pilot light and rectifier (1) Inlet voltage 12÷230 VAC Outlet voltage 9÷205 VDC	IP65	12 VAC	PG09	V86 25 0018
		24 VAC	PG09	V86 25 0019
		48 VAC	PG09	V86 25 0020
		115 VAC	PG09	V86 25 0021
		230 VAC	PG09	V86 25 0022

(1) do not use for proportional versions

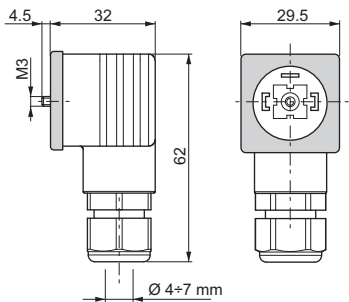

Connector	Protection level	Type	Cable gland	Code
With protection level IP67	IP67	Black color	—	V86 28 0001
		Grey color	—	V86 28 0002

Electrical features of connectors

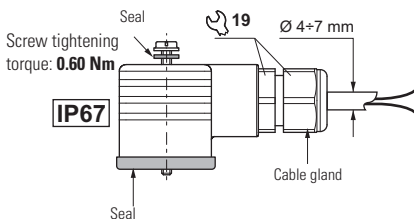
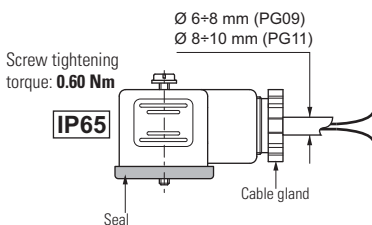

Description	IP65	IP67
AC rated voltage	Max. 250 V	Max. 250 V
DC rated voltage	Max. 300 V	Max. 300 V
Pin contact nominal current	10A	10A
Pin contact max. current	16A	16A
Max. section cable	1.5 mm ²	1.5 mm ²
Cable gland PG09 - M16x1,5	Ø cable 6 ÷ 8 mm	Ø cable 4 ÷ 7 mm
Cable gland PG11 - G 1/2" - M20x1,5	Ø cable 8 ÷ 10 mm	—
Protection level	IP65 EN60529	IP67 EN60529
Insulation class	VDE 0110-1/89	VDE 0110-1/89
Operating temperature	-40°C ÷ 90°C	-20°C ÷ 80°C

The degrees of protection indicate is guaranteed only if the connectors were properly mounted with his original seals.

Electrical circuits

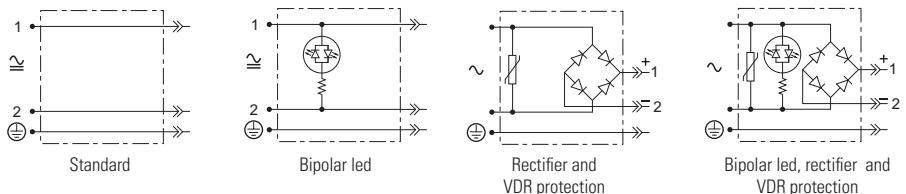

AMP JUNIOR CONNECTORS

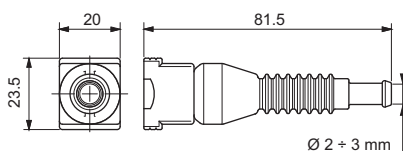

Connector	Type	Cable section	Pin contact max current	Code
AMP Junior connector Timer 2 contact	Black color	0.5 ÷ 1.5 mm ²	10A	RKRC0808000